



HITACHI

SERVICE MANUAL

TK

No. 1888E

**TRK-9100E/EZ/
E(BS)/E(AU)**

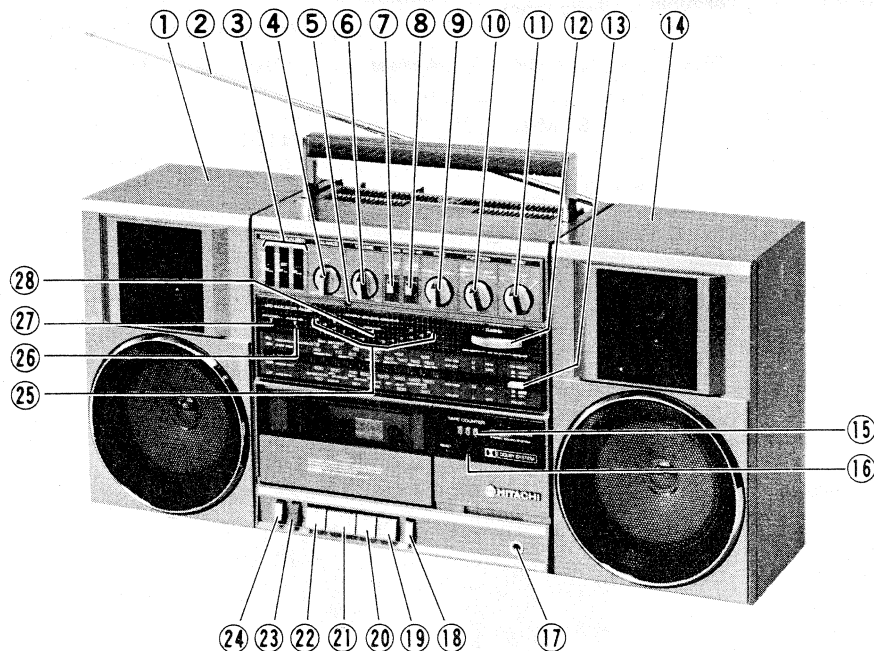

CONTENTS

SPECIFICATIONS.....	2
DISASSEMBLY.....	2
ADJUSTMENT.....	4
INSPECTION OF MECHANISM.....	6
LUBRICATION.....	6
SCHEMATIC DIAGRAM	
Tuner section.....	7
Tape recorder section.....	13
CIRCUIT BOARD DIAGRAM	
Tuner section.....	9
Tape recorder section.....	11
WIRING DIAGRAM.....	16
DIAL CORD STRINGING.....	19
REPLACEMENT PARTS LIST.....	20
EXPLODED VIEW.....	23

KEY TO ILLUSTRATIONS

- | | |
|----------------------------------|---------------------------|
| ① SPEAKER BOX (LEFT) | ⑮ TAPE COUNTER |
| ② TELESCOPIC ANTENNA (AERIAL) | ⑯ COUNTER RESET BUTTON |
| ③ GRAPHIC EQUALIZER CONTROLS | ⑰ HEADPHONES SOCKET |
| ④ BALANCE CONTROL | ⑱ PAUSE BUTTON |
| ⑤ BUILT IN MICROPHONE (MONAURAL) | ⑲ STOP BUTTON |
| ⑥ VOLUME CONTROL | ⑳ FAST FORWARD/CUE BUTTON |
| ⑦ LOUDNESS SWITCH | ㉑ PLAYBACK BUTTON |
| ⑧ DOLBY NR SWITCH | ㉒ REWIND/REVIEW BUTTON |
| ⑨ TAPE SELECTOR | ㉓ RECORD BUTTON |
| ⑩ FUNCTION SELECTOR | ㉔ EJECT BUTTON |
| ⑪ BAND SELECTOR | ㉕ LED LEVEL INDICATORS |
| ⑫ TUNING CONTROL | ㉖ DOLBY NR INDICATOR |
| ⑬ FM MODE/FM AFC SWITCH | ㉗ FM STEREO INDICATOR |
| ⑭ SPEAKER BOX (RIGHT) | ㉘ OPERATION INDICATORS |

SAFETY PRECAUTION

The following precautions should be observed when servicing.

- Since many parts in the unit have special safety-related characteristics, always use genuine Hitachi's replacement parts. Especially critical parts in the power circuit block should not be replaced with other makes. Critical parts are marked with Δ in the schematic diagram and circuit board diagram.
- Before returning a repaired unit to the customer, the service technician must thoroughly test the unit to ascertain that it is completely safe to operate without danger of electrical shock.

SPECIFICATIONS AND PARTS ARE SUBJECT TO CHANGE FOR IMPROVEMENT

FM/SW/MW/LW RADIO CASSETTE TAPE RECORDER

Feb. 1983

TOKAI WORKS

SPECIFICATIONS

GENERAL SECTION

Semi-conductors : ICs : 8
 Transistors : 10 [E/E(BS)/E(AU)]
 11 [EZ]
 Diodes : 4
 LEDs : 13
 Varicap : 1
 Power (Mains) Supply : AC : 220V, 50Hz [E/EZ]
 240V, 50Hz [E(BS)/E(AU)]
 DC : 12V (IEC R20 x 8 or equivalent)
 Power (Mains) Consumption : 28W [E/EZ]
 24W [E(BS)/E(AU)]
 Power output : 15W M.P.O. (AC operation)
 5W/CH (10% T.H.D.DC)
 Speakers : 12cm, 2.8 ohms x 2
 3cm, 3000 ohms x 2
 2cm, 500 ohms x 2
 Dimensions : 54.2 (W) x 25.3 (H) x 17.7 (D) cm
 Weight : 7.4 kg (with batteries)

Antennas (Aerials) : FM/SW : Telescopic antenna (aerial)
 MW/LW : Ferrite-core antenna (aerial)

TAPE RECORDER SECTION

Tape : Cassette tape (C-30, 60, 90)
 Tape Speed : 4.75cm/s
 Recording System : AC bias, 57kHz
 Erasing System : AC erasing
 Frequency Response : METAL ; 40 to 14,000Hz
 CrO₂ ; 40 to 13,000Hz
 Normal ; 40 to 12,000Hz
 S/N (Signal to Noise Ratio) : 60dB (Dolby NR ON)
 Wow & Flutter : 0.08% (WRMS)
 Crosstalk : Between tracks : 50dB
 Between channels : 30dB
 Erase Ratio : 65dB
 Input sensitivity and Impedance : Microphone : 4mV, 600 ohms
 DIN : 0.5mV/k ohms, 20k ohms
 Phono : 6mV, 50k ohms
 Output Level and Impedance : DIN : 450mV, 5k ohms
 Headphone : 8 ohms - 300 ohms
 Ext. speaker : 2.8 - 8 ohms
 Fast Forward or Rewinding Time : 120sec (Using C-60)
 Distortion : 2 %
 Motor : DC micromotor

TUNER SECTION

Circuit System : FM/SW/MW/LW 4-band superheterodyne
 Tuning Range : FM : 87.5 to 108MHz
 SW : 6 to 18MHz
 MW : 530 to 1605kHz
 LW : 150 to 350kHz
 Sensitivity : FM : 10dB (pra.), 0dB (max.)
 SW : 25dB (pra.), 20dB (max.)
 MW : 45dB (pra.), 35dB (max.)
 LW : 52dB (pra.), 40dB (max.)
 Intermediate Frequency : FM : 10.7MHz
 SW/MW/LW : 468kHz

DISASSEMBLY

1. Rear case

- 1) Remove eight knobs (Band, Function, Tape, Volume, Balance, Graphic Equalizers) and remove (A) (six) screws.
- 2) Open the cassette lid and remove the rear case.

2. Cassette lid

Push the cassette lid arm in the direction of the arrow and pull out the cassette lid.

3. Function button assembly

Insert a ⊖ screwdriver into the recess in the front case and push out the function button assembly.

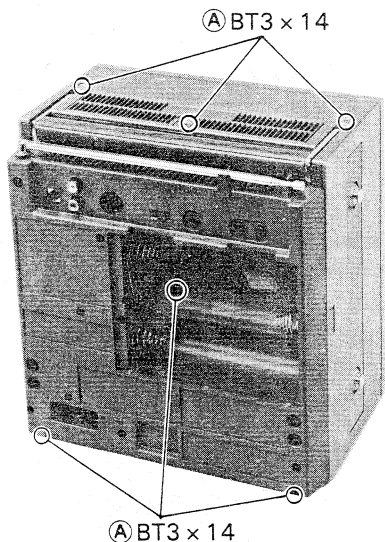

Fig. 1

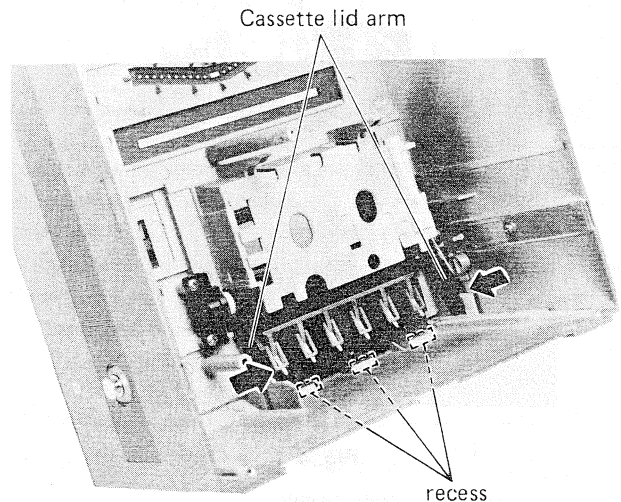

Fig. 2

4. Cassette chassis

Remove **B** spring and **C** (four) screws.

5. Control PC board

Remove **D** (two) screws.

6. PC board holder

Remove **E** (two) screws.

7. Headphone PC board

Remove **F** (one) nut and **G** (two) screws.

9. Dial cord stringing holder

Remove **I** (three) screws.

10. Power PC board

Remove **J** (four) screws and **K** (two) connectors.

11. Main PC board and record arm

Remove **L** (three) screws.

28
27
26
25

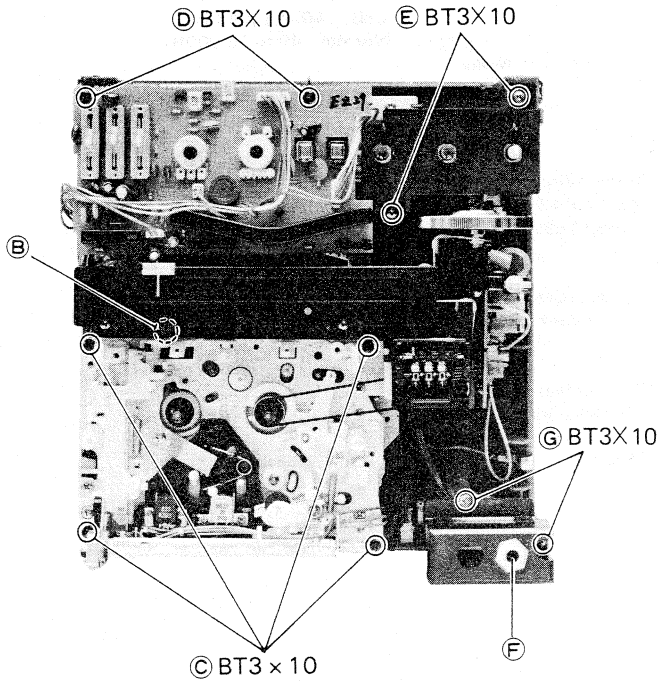

Fig. 3

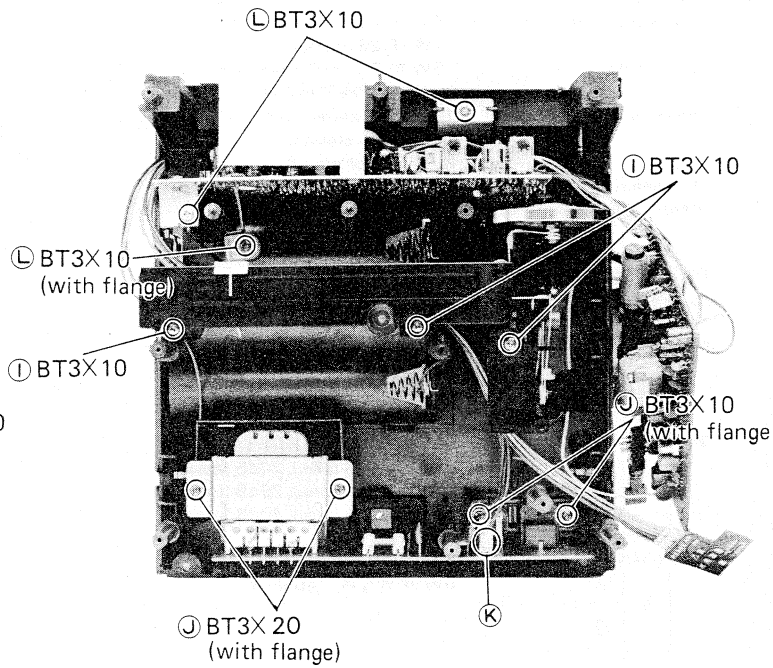

Fig. 5

8. Tuner PC board

Remove **H** (two) screws.

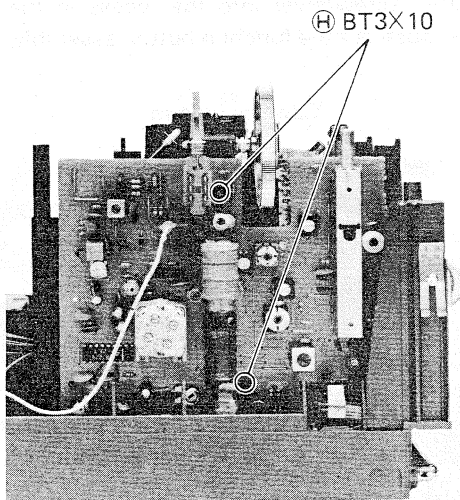

Fig. 4

ADJUSTMENT

1. Tuner Section

* For TRK-9100EZ

Step	Adjustment Item	Measuring Instrument and Connection			Genescope or Signal Generator Frequency	Dial Pointer Position	Adjust	Reading
		Measuring Instrument	Input Terminal	Output Terminal				
1	(1) FM IF	● Genescope (10.7 MHz)	TP103	TP201	10.7 MHz	Highest	T101	Note 1
2	(1) FM OSC. (Covering)	● FM signal generator (400 Hz 30% mod.) ● Oscilloscope ● VTVM	TP101, 102 (thru FM dummy antenna) [Note 2]	TP201	87 MHz (87.5 MHz*)	Lowest	L102	Output Max.
					109 MHz (108 MHz*)	Highest	CT102	
					Repeat steps (1) and (2)			
3	(1) FM ANT. (Tracking)				90 MHz	90 MHz	L101	Output Max.
					106 MHz	106 MHz	CT101	
					Repeat steps (1) and (2)			
4	(1) FM MPX (Multiplex)	● Frequency counter	Connect a 10 μ F 25V electrolytic capacitor between the No. 2 pin of IC301 and ground.	TP301	—	—	RT301	19 kHz \pm 200Hz (Note 3)
5	(1) AM IF	● Genescope (468 kHz)	Ferrite-core antenna (Note 4)	TP201	468 kHz	Highest	—	Note 5
6	(1) LW OSC. (Covering)	● AM signal generator (400 Hz, 30% mod.) ● VTVM	Ferrite-core antenna (Note 4)	TP201	145 kHz	Lowest	L156	Output Max.
					360 kHz	Highest	CT156	
					Repeat steps (1) and (2)			
7	(1) LW ANT. (Tracking)				160 kHz	160 MHz	L153	Output Max.
					330 kHz	330 kHz	CT153	
					Repeat steps (1) and (2)			
8	(1) MW OSC. (Covering)	● AM signal generator (400 Hz, 30% mod.) ● VTVM	Ferrite-core antenna (Note 4)	TP201	515 kHz	Lowest	L155	Output Max.
					1650 kHz	Highest	CT155	
					Repeat steps (1) and (2)			
9	(1) MW ANT. (Tracking)				600 kHz	600 kHz	L152	Output Max.
					1400 kHz	1400 kHz	CT152	
					Repeat steps (1) and (2)			
10	(1) SW OSC. (Covering)	● AM signal generator (400 Hz, 30% mod.) ● VTVM	TP101, 102 (thru SW dummy antenna) [Note 6]	TP201	5.8 MHz	Lowest	L154	Output Max.
					18.5 MHz	Highest	CT154	
					Repeat steps (1) and (2)			
11	(1) SW ANT. (Tracking)				6.5 MHz	6.5 MHz	L151	Output Max.
					16 MHz	16 MHz	CT151	
					Repeat steps (1) and (2)			

Note :

1. Feed in a weak signal to TP103 from the genescoper. Adjust the T101 core to form the S-curve shown in Figure 6. Adjust the symmetry of A and B about point C for linearity.

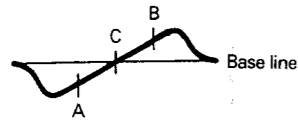

Fig. 6

2. FM dummy antenna shows Figure 7.

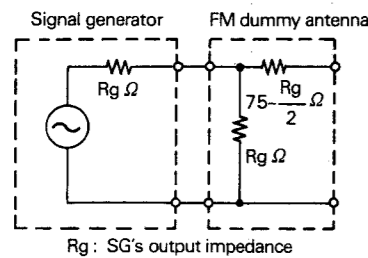
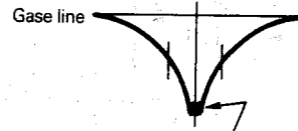

Fig. 7

3. Connect the frequency counter to TP301, via a resistor of 100 kΩ.
4. Connect AM signal generator to loop antenna, bring near to ferrite antenna.
5. Feed in a weak signal from the genescoper and confirm that the waveform is obtained shown in Figure 8.



Adjust the genescoper output so that there is a little noise riding on the leading edge.

Fig. 8

6. SW dummy antenna shows Figure 9.

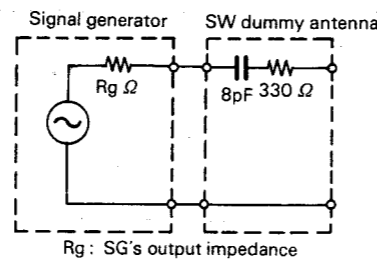

Fig. 9

2. Tape Recorder Section

Perform the following adjustments in the sequence stated after cleaning the head, pressure roller, and capstan with a head cleaning stick moistened in alcohol.

Also, unless otherwise specified, set the switches to the positions indicated in the table.

Symbol No.	Switches	Position
S4	Tape select switch	NORMAL
S5	Function selector	TAPE
S6	Dolby NR switch	OFF

Step	Adjustment Item	Measuring Instrument and connection			Check Tape	Mode	Adjusted Position	Adjusted Value	Remarks
		Measuring Instrument	Input Terminal	Output Terminal					
1	Head azimuth	• VTVM	—	DIN socket (output)	Head azimuth test tape (10 kHz)	Playback	Azimuth adjusting screw	Output Max.	Note 1
2	Playback gain	• VTVM	—	TP401L, R	Dolby test tape (400 Hz, 200 nWb/m)	Playback	RT401L, R	450 mV (<input type="checkbox"/> <input type="checkbox"/> +3 dB)	Note 2
3	Record/playback frequency characteristics	Set the RIF switch to A position			NORMAL tape	Record/playback	RT402, R	Output difference within ± 2 dB	Note 3
		• Audio oscillator (1.25 kHz/12.5 kHz) • Attenuator • VTVM	DIN socket (input)	TP401L, R					

Note :

1. When the maximum values of both channels are different, adjust to the maximum value of the L channel. In this case, the difference between the maximum values of both channels should be within 2dB.
- 1) Playback a Dolby test tape (400Hz, 200 nWb/m) and adjust RT401L, R so that the level of TP1L, R becomes 450 mV.
- 2) Confirm that the +3dB level indicators () light.

3. 1) Feed a 1.25 kHz signal to the DIN socket (input) in the recording mode and adjust the audio oscillator so that the level of TP401L, R becomes 450 mV. Then, adjust the attenuator to lower the output level by 20 dB.
- 2) Record the signal on NORMAL tape with the conditions of item 1), then continue to record with the audio oscillator frequency set to 12.5 kHz.
- 3) Playback the recorded signal and adjust RT402L, R so that the output level difference between two frequencies is within ± 2dB.

INSPECTION OF MECHANISM

Item No.	Inspection item	Reference value	Remarks
1	Pressure of pressure roller	375 ± 75 g	Note 1
2	Take-up torque	30 ~ 55 g·cm	
3	East forward torque	75 ~ 115 g·cm	
4	Rewind torque	75 ~ 115 g·cm	
5	Supply reel back-tension	2.0 ~ 4.5 g·cm	Without counter
6	Take-up reel back-tension	2.0 ~ 4.0 g·cm	Without counter
7	Brake force	10 g·cm or more	
8	PLAY, REC, FF, REW, STOP buttons	0.25 kg or less	
9	PAUSE button	0.3 kg or less	
10	Flywheel thrust gap	0.05 ~ 0.5 mm	

Note 1

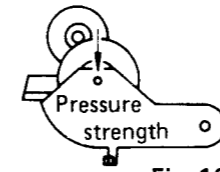

Fig. 10

LUBRICATION

Lubricate one or two drops of oil to rotating point or lubricate grease to sliding point. Lubricate the respective parts listed once every 1000 hours or once a year under normal conditions of use. Avoid oiling them excessively, or rotation may become irregular because of oil splashes.

Lubrication		Oil or Grease
Rotary Section	Metal and metal	Pan motor oil (10W-40)
	Mold and metal	Sonic slider oil (# 1600)
Sliding section	Metal and metal	Hitasol (MO-138)
	Mold and mold Mold and metal	White grease (FL-LUBE-A)
Spring resonance prevention		Floil (GB-TS-1)

SCHEMATIC DIAGRAM (Tuner Section)

D101 ISS133 PROTECTOR	IC101 AN7213 A FM RF AMP./ FM CONV.	D102 IS2740 AFC	Q171 2SC380 BUFFER AMP. (EZ ONLY)	D103 ISS133 LIMITER	Q201 2SC380 FM IF AMP.	D301 ISS133 SWITCHING	IC301 BA1330 FM MPX	IC201 AN7224 FM/AM IF AMP. AM RF AMP.
-----------------------------	--	-----------------------	--	---------------------------	------------------------------	-----------------------------	---------------------------	--

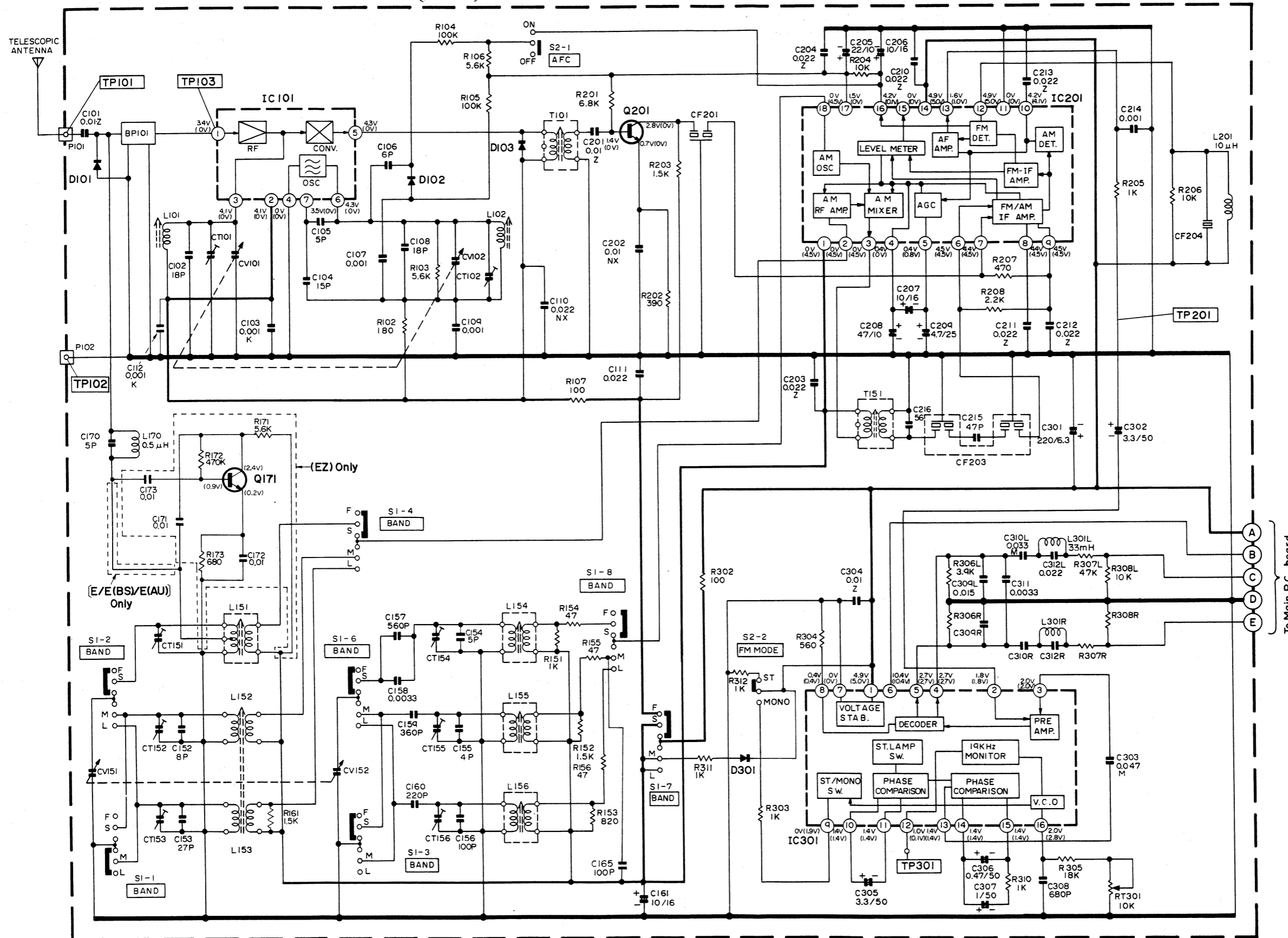

Voltagess are measured in FM mode.
inside () voltagess are measured in AM mode.

CIRCUIT BOARD DIAGRAM (Tuner Section)

Note

- 1. Voltage measured at base of chassis with minimum volume control and no signal.
- 2. Nomenclature of Resistors and Capacitors.

Circuit No.	
Value	No indicated Ω (Ohm) M : 1000 kΩ
Tolerance	No indicated ±5% K : ±10% M : ±20%
Wattage	No indicated ¼W
Sort	No indicated Carbon film RC : Composition RW : Wire wound RS : Oxide metal film RN : Fixed metal film

Circuit No.	
Value	No indicated μF P : PF
Tolerance	No indicated ±10% J : ±5% M : ±20% Z : +80% -20% D : ±0.5pF C : ±0.25pF
Sort	Ceramic
	Electrolytic
	Mylar
	Polyster
Voltage	Styrol
	No indicated 50WV

- 3. Be sure to make your orders of resistors and capacitors with value, voltage, tolerance and sort.
- 4. When replacing capacitors marked with *, use specified ones stated on parts list since required temperature characteristics.

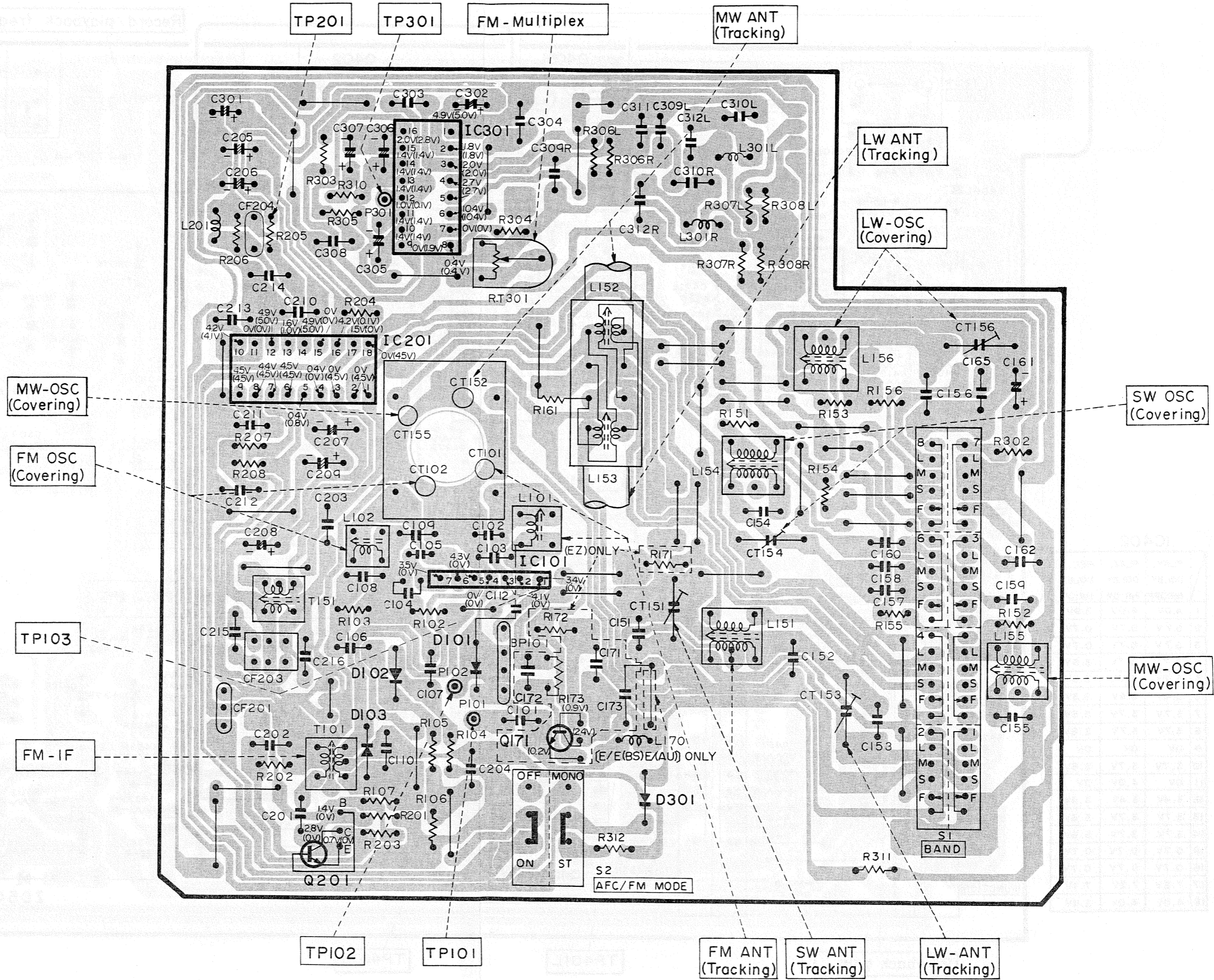

CIRCUIT BOARD DIAGRAM (Tape Recorder Section)

Record/playback frequency characteristics

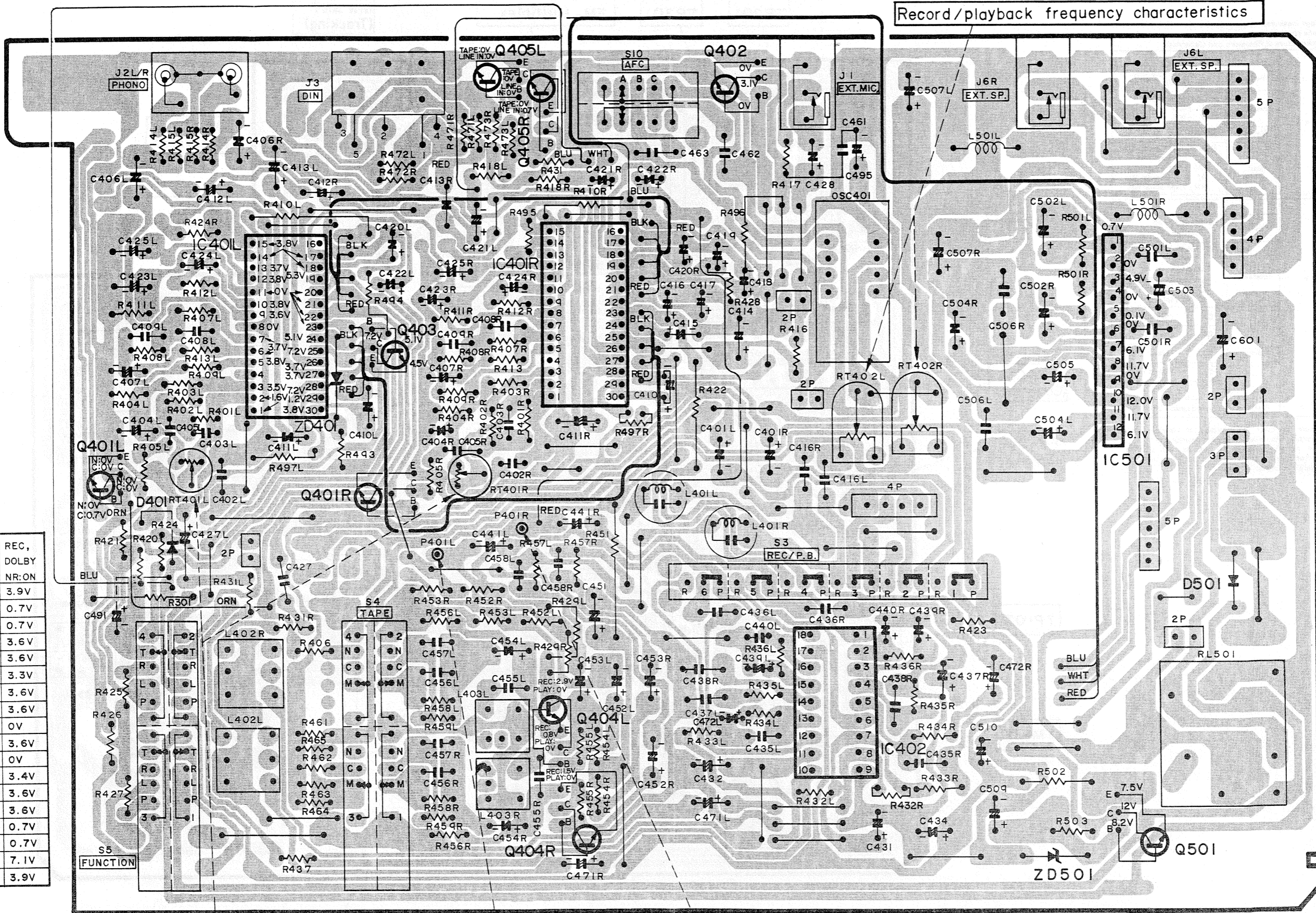

IC402

	PLAY, DOLBY NR:OFF	PLAY, DOLBY NR:ON	REC, DOLBY NR:ON
1	4.0V	4.0V	3.9V
2	0.7V	0.7V	0.7V
3	0.7V	0.7V	0.7V
4	3.7V	3.7V	3.6V
5	3.7V	3.7V	3.6V
6	3.4V	3.4V	3.3V
7	3.7V	3.7V	3.6V
8	3.7V	3.7V	3.6V
9	0V	0V	0V
10	3.7V	3.7V	3.6V
11	0V	4.9V	0V
12	3.4V	3.4V	3.4V
13	3.7V	3.7V	3.6V
14	3.7V	3.7V	3.6V
15	0.7V	0.7V	0.7V
16	0.7V	0.7V	0.7V
17	7.2V	7.2V	7.1V
18	4.0V	4.0V	3.9V

Playback gain

TP401L

TP401R

SCHEMATIC DIAGRAM (Tape Recorder Section)

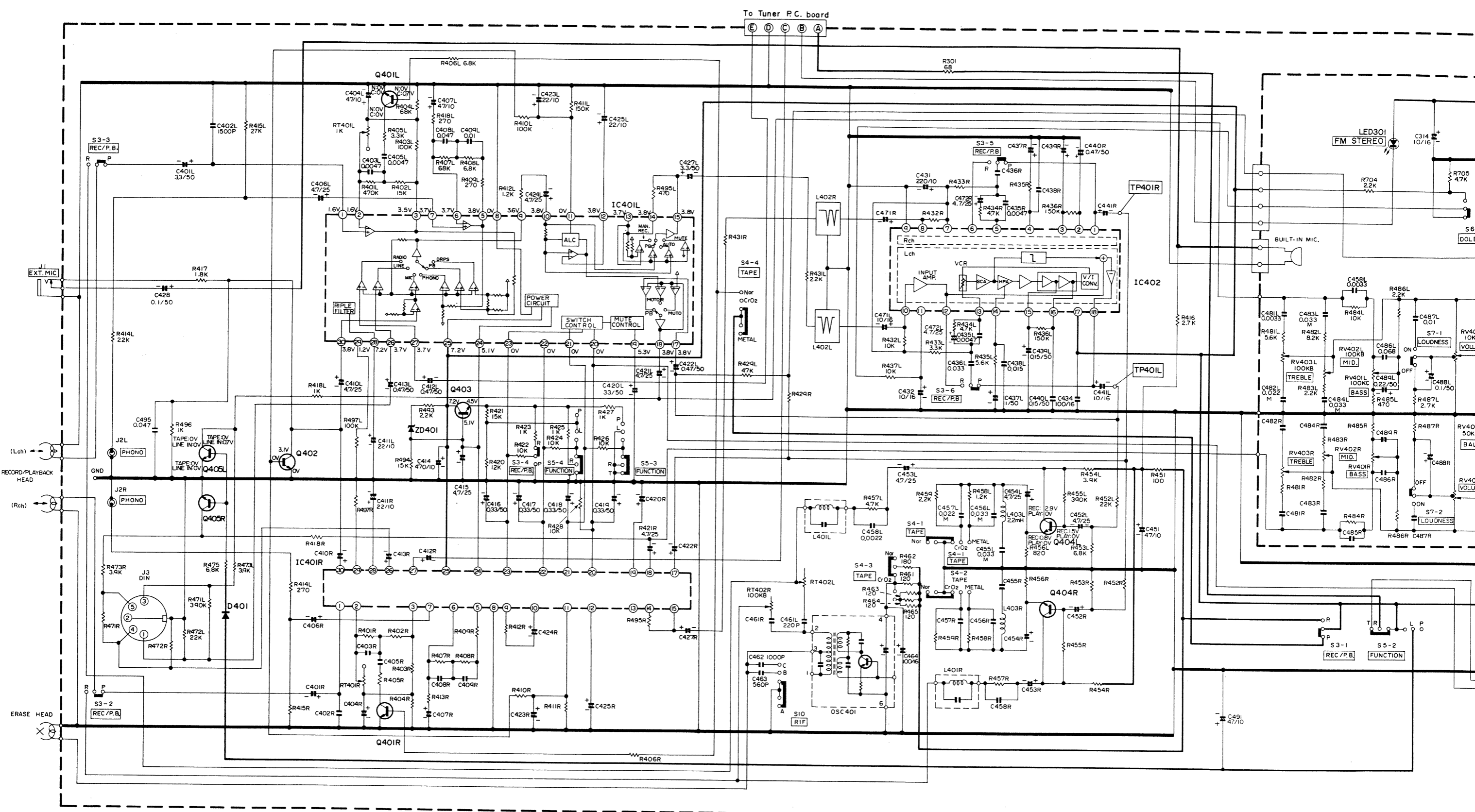

- Q405L,R
2SC458
DIN MUTE
- Q402
2SC1740LN-R
MIC. ALC
- Q401L,R
2SC458
SWITCHING
- ZD401
HZ-28
VOLT. STAB.
- Q403
2SC458
REGULATOR
- D401
1S2473
PROTECTOR
- IC401L,R
HA12037
PRE/LINE AMP.
- IC402
HA12046
DOLBY NR
- Q404L,R
2SC1740LN-R
REC./EQ. AMP.
- IC501
HA1392
POWER AMP.
- LED301
GL-9PR2
FM ST. IND.
- LED401
GL-9P62
DOLBY NR IND.
- I
BA6
LED D

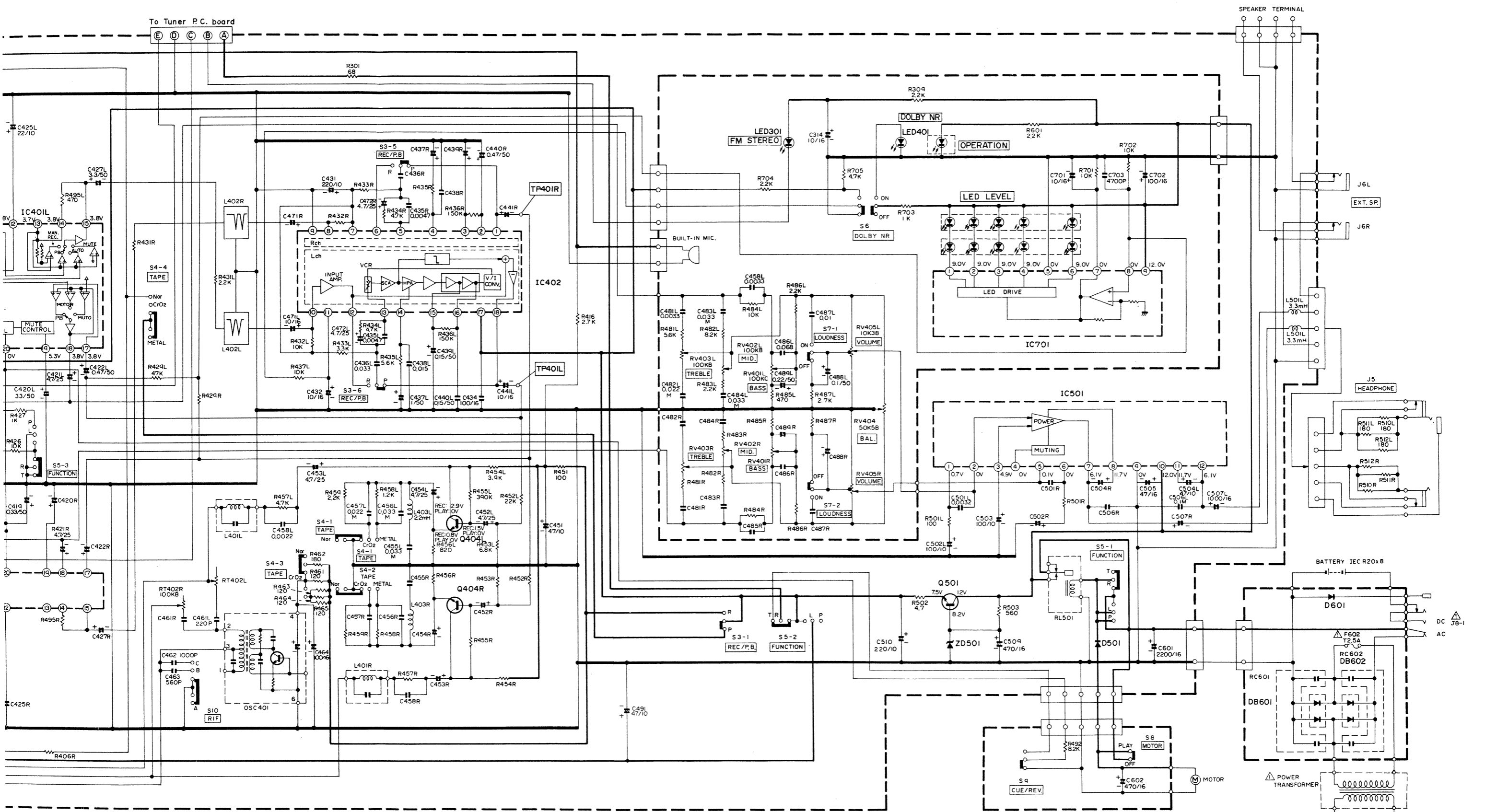

- IC401L,R
HA 12037
PRE/LINE AMP.
- IC402
HA12046
DOLBY NR
- Q404L,R
2SC1740LN-R
REC./EQ. AMP.
- IC501
HA 1392
POWER AMP.
- LED301
GL-9PR2
FM ST. IND.
- LED401
GL-9PG2
DOLBY NR IND.
- IC701
BA6137
LED DRIVER
- ZD501
HZ 9A2
VOLT. STAB.
- Q501
25C1162WT-C
VOLT. STAB.
- D501
ISS133
SWITCHING PROTECTOR
- D601
V03C
RECT.
- DB601
SRN02-100NLF
RECT.
- DB602
SRP02-100NLF
RECT.

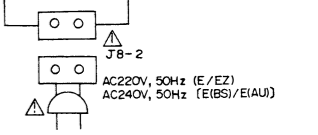

WIRING DIAGRAM

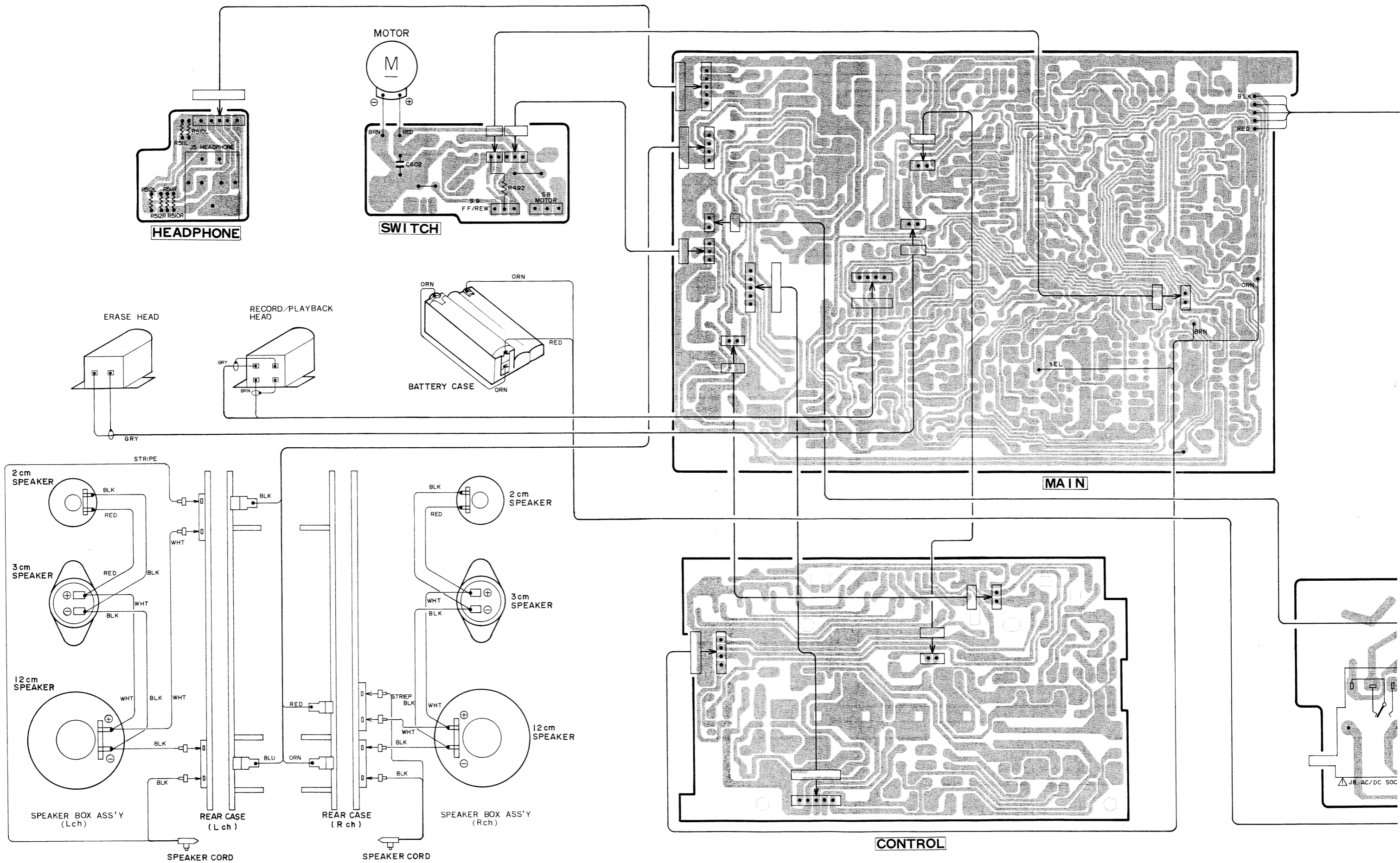

WIRING DIAGRAM

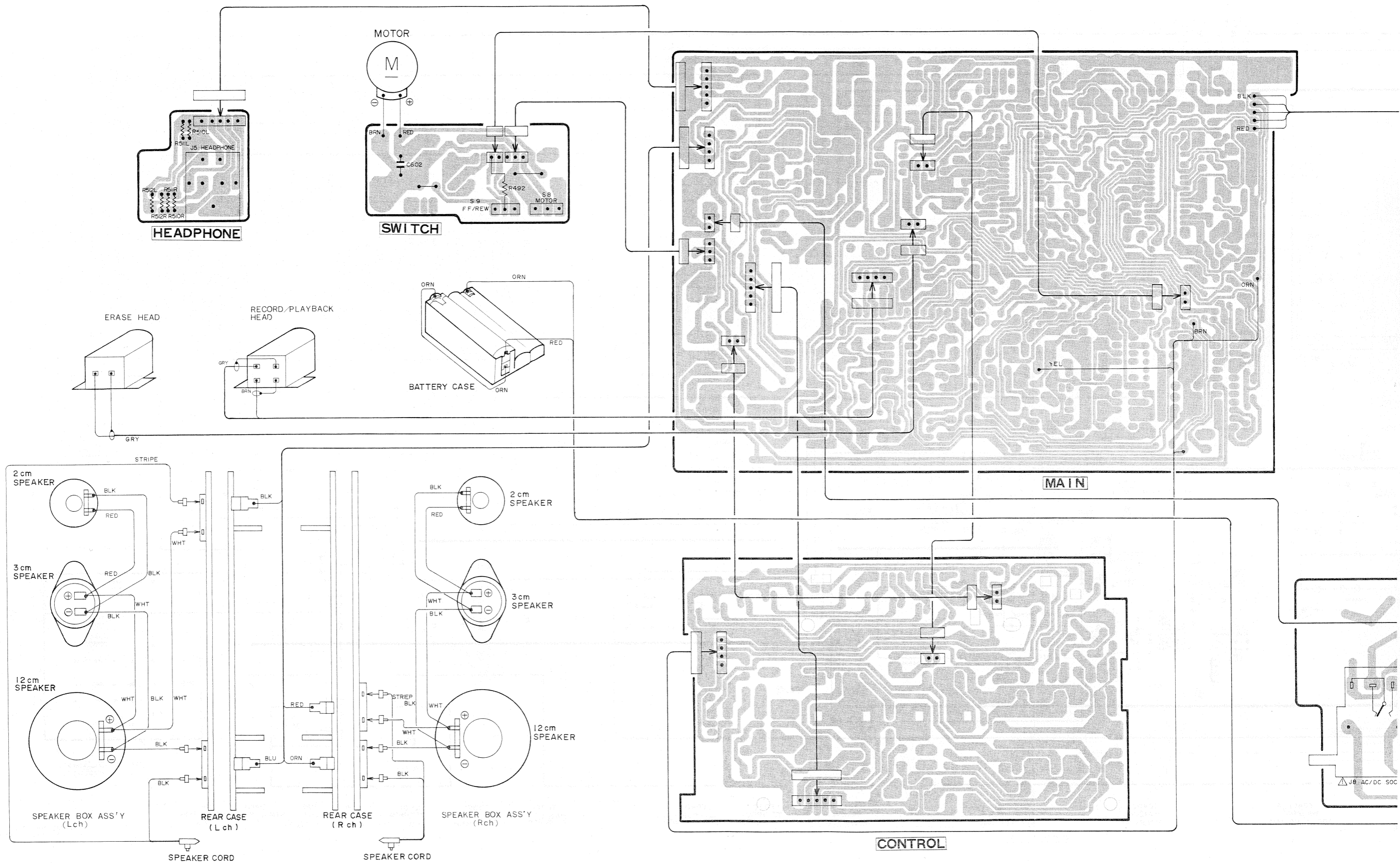

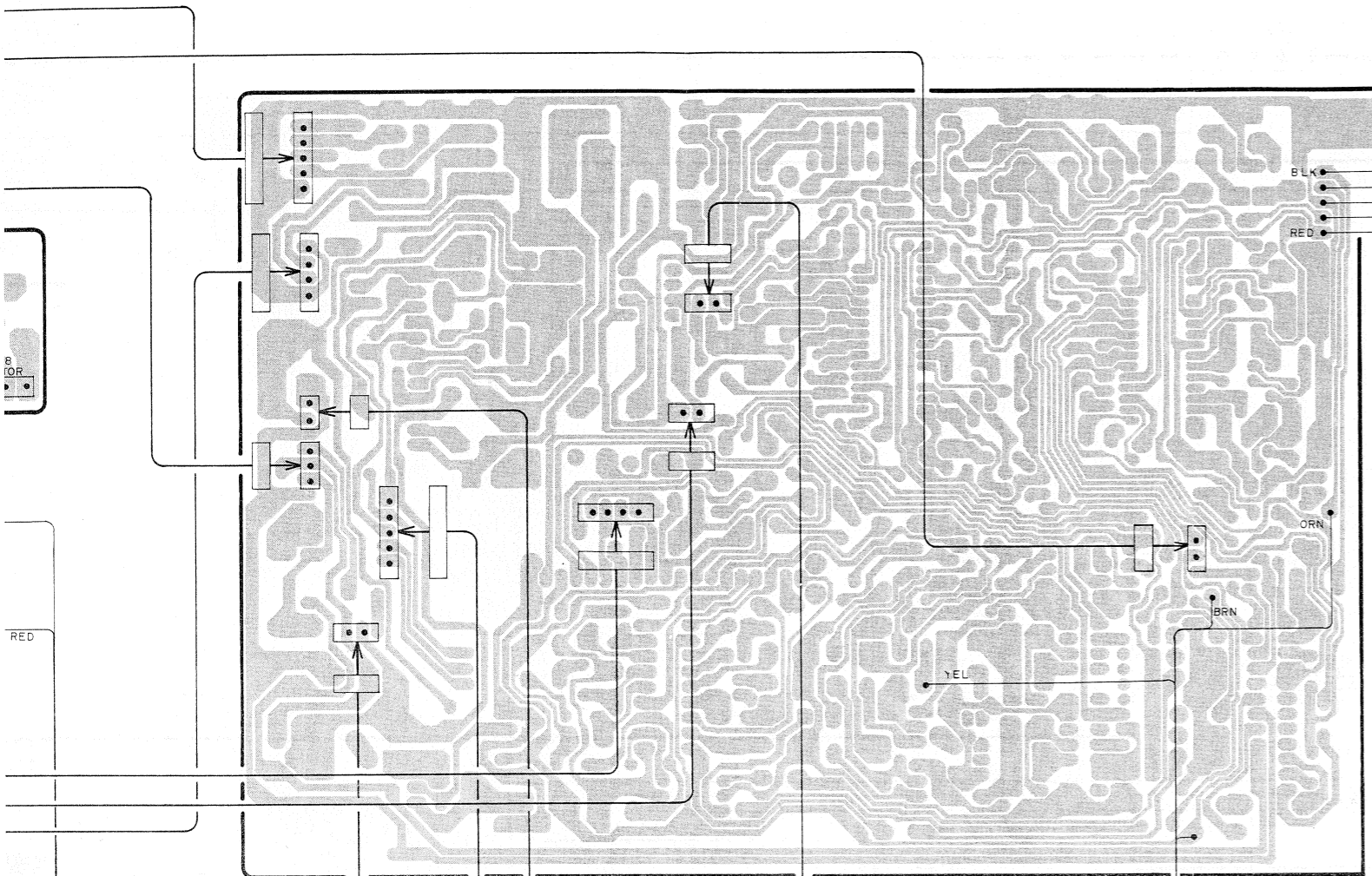

MAIN

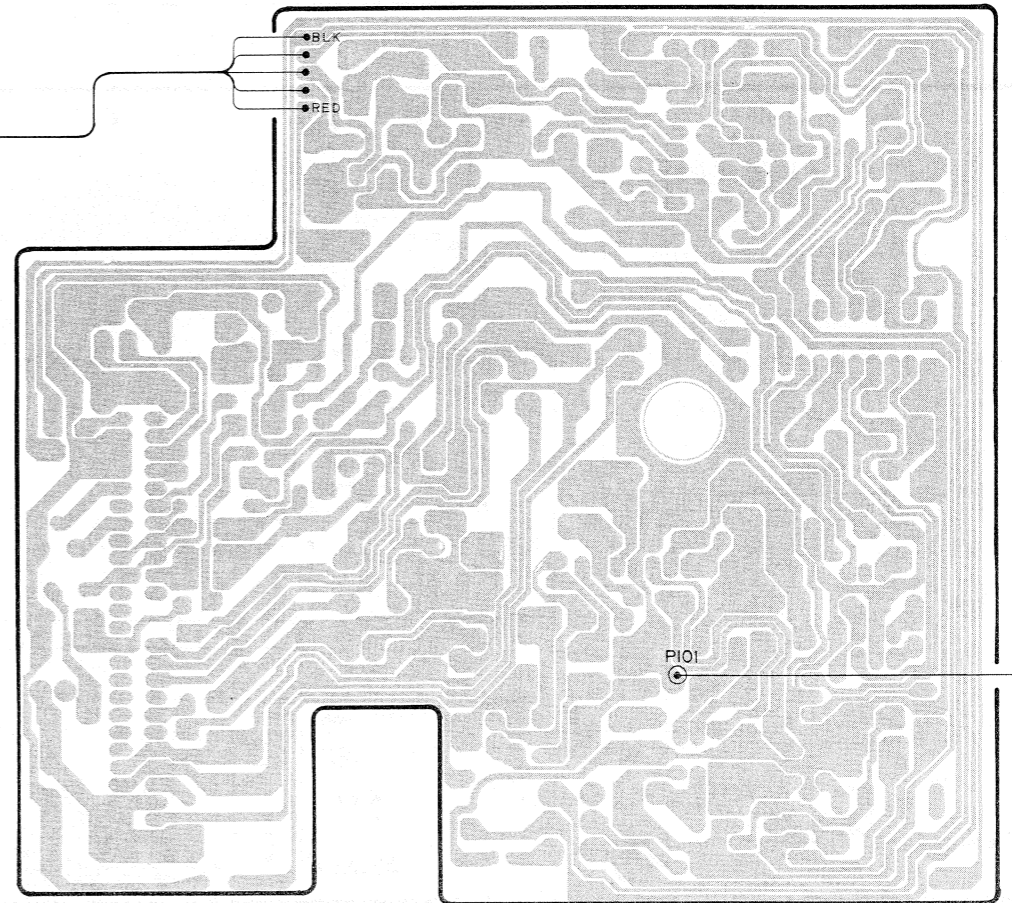

TUNER

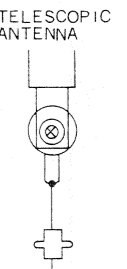

TELESCOPIC ANTENNA

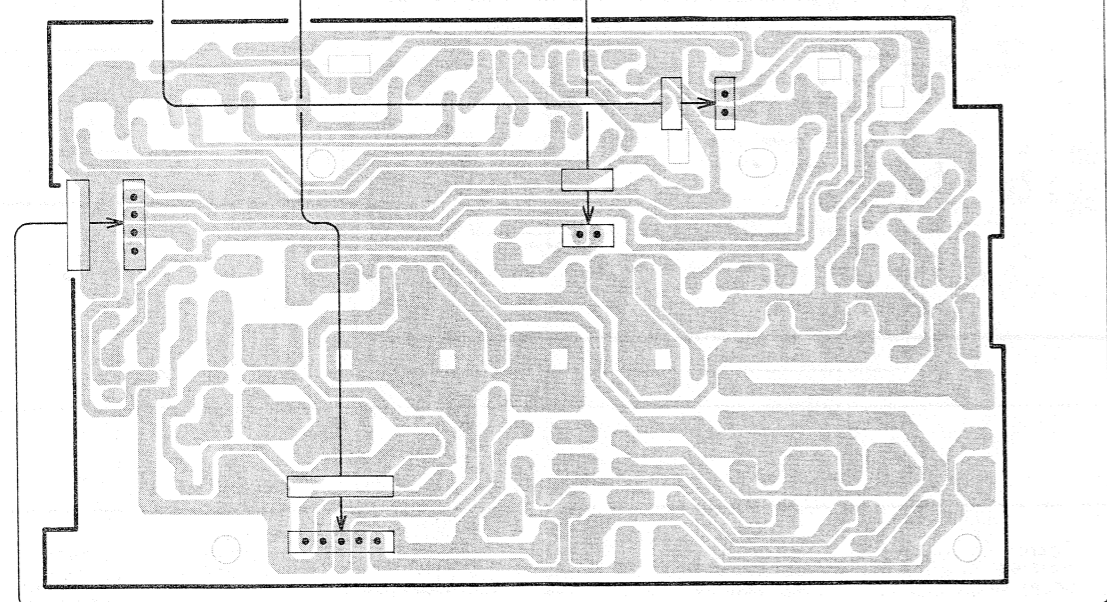

CONTROL

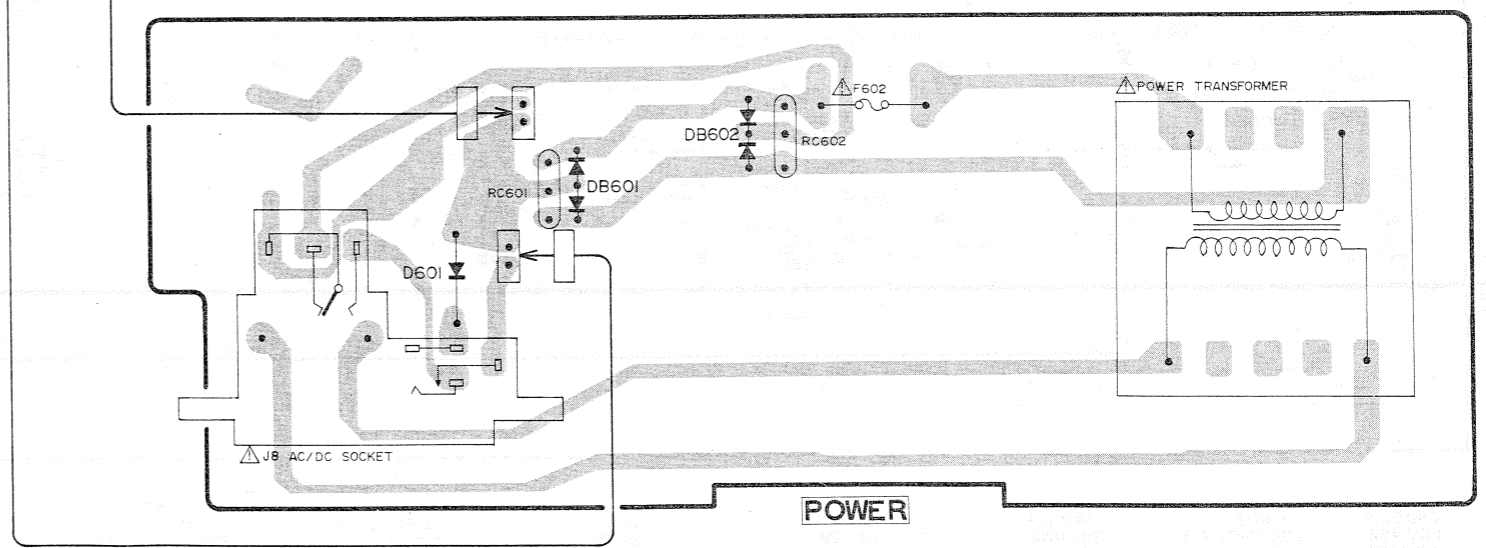

POWER

CIRCUIT BOARD DIAGRAM

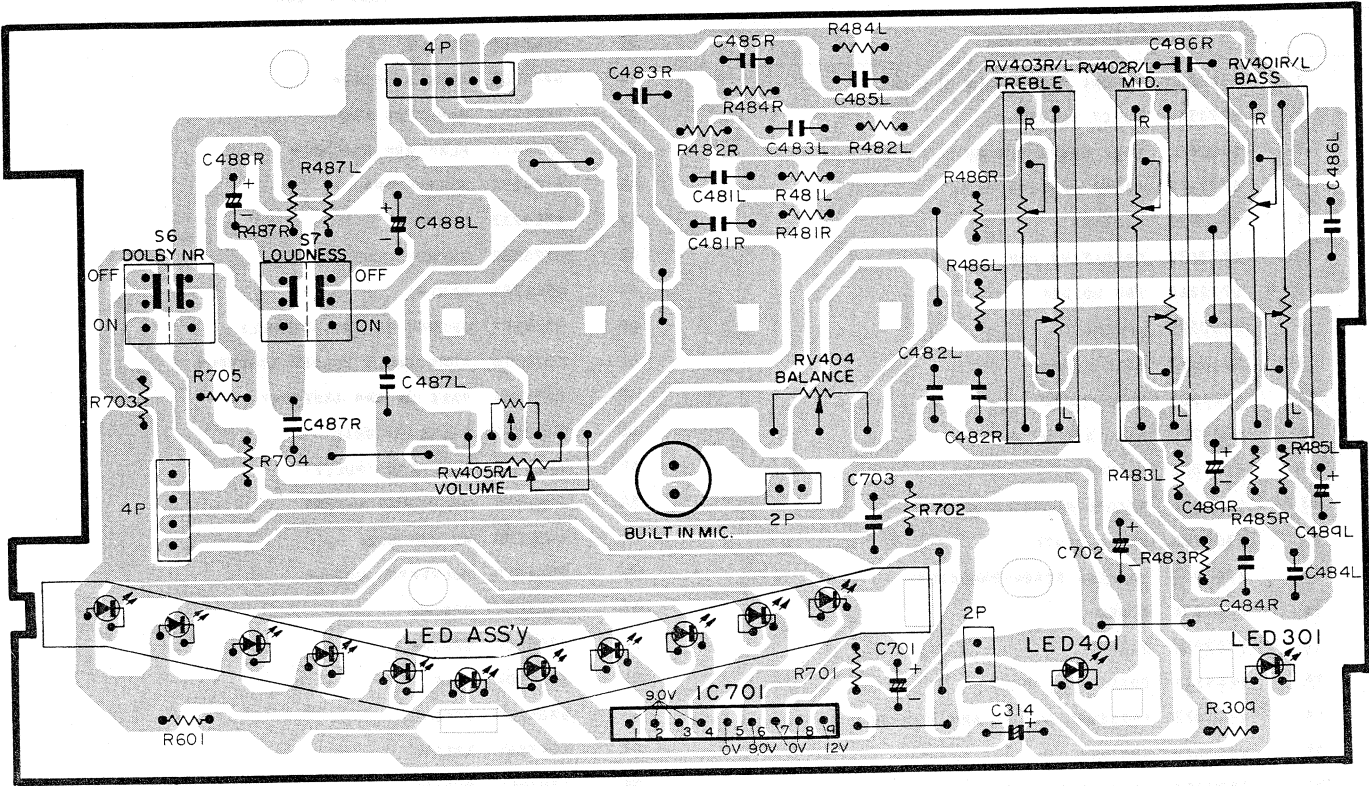

DIAL CORD STRINGING

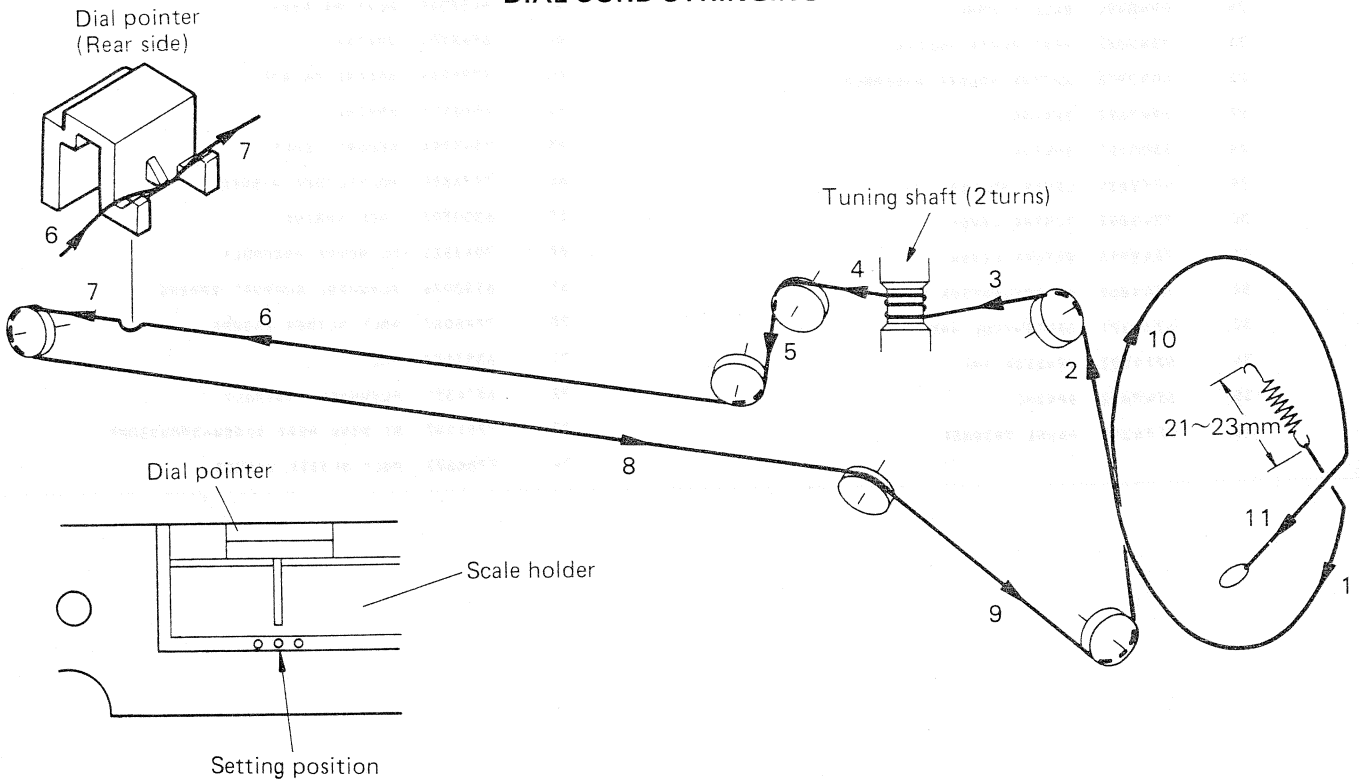

Stringing Method

1. Turn the pulley fully clockwise.
2. String the dial cord in the direction of the arrow (Nos. 1 – 11).
3. Set the dial pointer to setting position.

REPLACEMENT PARTS LIST

SYMBOL-NO	P-NO	DESCRIPTION	SYMBOL-NO	P-NO	DESCRIPTION
MECHANISM (FZ-11B)			37	6548261	SPRING
1	7345871	RECORD PREVENTION SLIDER	38	6774201	AUTO STOP ARM
2	6771344	EJECT SLIDER	39	6771474	FUNCTION ARM
3	6301011	LOCK LEVER SPRING	40	6771413	PLAY ARM ASSEMBLY
4	6773822	PAUSE SENSING ARM	41	6774231	SWITCH ARM
5	6547923	SPRING	42	6301233	SPRING
6	6773832	OPERATING ARM	43	6773332	SEARCH STOPPER
7	6772843	ARM HOLDER	44	6548281	SPRING
8	6300595	SPRING	45	7345807	RECORD SLIDER ASSEMBLY
9	0948492	BALL - 2MMD	46	6771716	TURN TABLE HOLDER ASSEMBLY
10	6771336	HEAD PLATE	47	6771366	TAKE UP ARM ASSEMBLY
11	6321733	HEAD SPRING C	48	6432212	PAUSE PA GEAR
12	7757042	SPACER	49	6422772	AUTO STOP PULLEY
13	5449032	RECORD PLAYBACK HEAD	50	7786115	POLYESTER WASHER
14	7339961	EARTH PLATE	51	6432073	AS CAM GEAR
15	7780913	TAPPING SCREW-2MMDX10MM	52	7786115	POLYESTER WASHER
16	7781004	SCREW	53	6301331	SPRING
17	7757052	SPACER	54	6301101	SPRING
18	5445531	ERASE HEAD	55	6355504	BELT
19	6771072	PRESSURE ROLLER ARM ASSEMBLY	56	6301331	SPRING
20	6547692	SPRING	57	6547561	SPRING
21	7778859	POLYSLIDER WASHER	58	6301001	SPRING
22	6301101	SPRING	59	6432053	FF PA GEAR
23	6547571	HEAD PLATE SPRING	60	6432061	REWIND PA GEAR
24	0948492	BALL - 2MMD	61	6432042	PLAY PA GEAR
25	7345882	HEAD PLATE HOLDER	62	6548121	SPRING
26	6057975	BUTTON HOLDER ASSEMBLY	63	6771244	RECORD PA ARM
27	6547642	SPRING	64	6548112	SPRING
28	6300181	SPRING	65	7345994	RECORD LEVER
29	6772831	LEVER HOLDER	66	7778859	POLYSLIDER WASHER
30	7345892	TIMING LEVER	67	6300592	LOCK SPRING
31	7345913	RETURN LEVER	68	7043325	DC MOTOR ASSEMBLY
32	7345862	AS PREVENTION LEVER	69	6530926	FLYWHEEL SUPPORT SPRING
33	6774221	REVIEW/CUE ARM	70	7788067	POLY SLIDER WASHER
34	6771082	TENSION ARM	71	6355309	BELT
35	6547622	SPRING	72	6374551	FLYWHEEL ASSEMBLY
36	6774211	PAUSE TRIGGER	73	7781147	BT BIND HEAD SCREW-3MMDX30MM
			74	7786623	POLY SLIDER WASHER

EXPLODED VIEW (Mechanism FZ-11B)

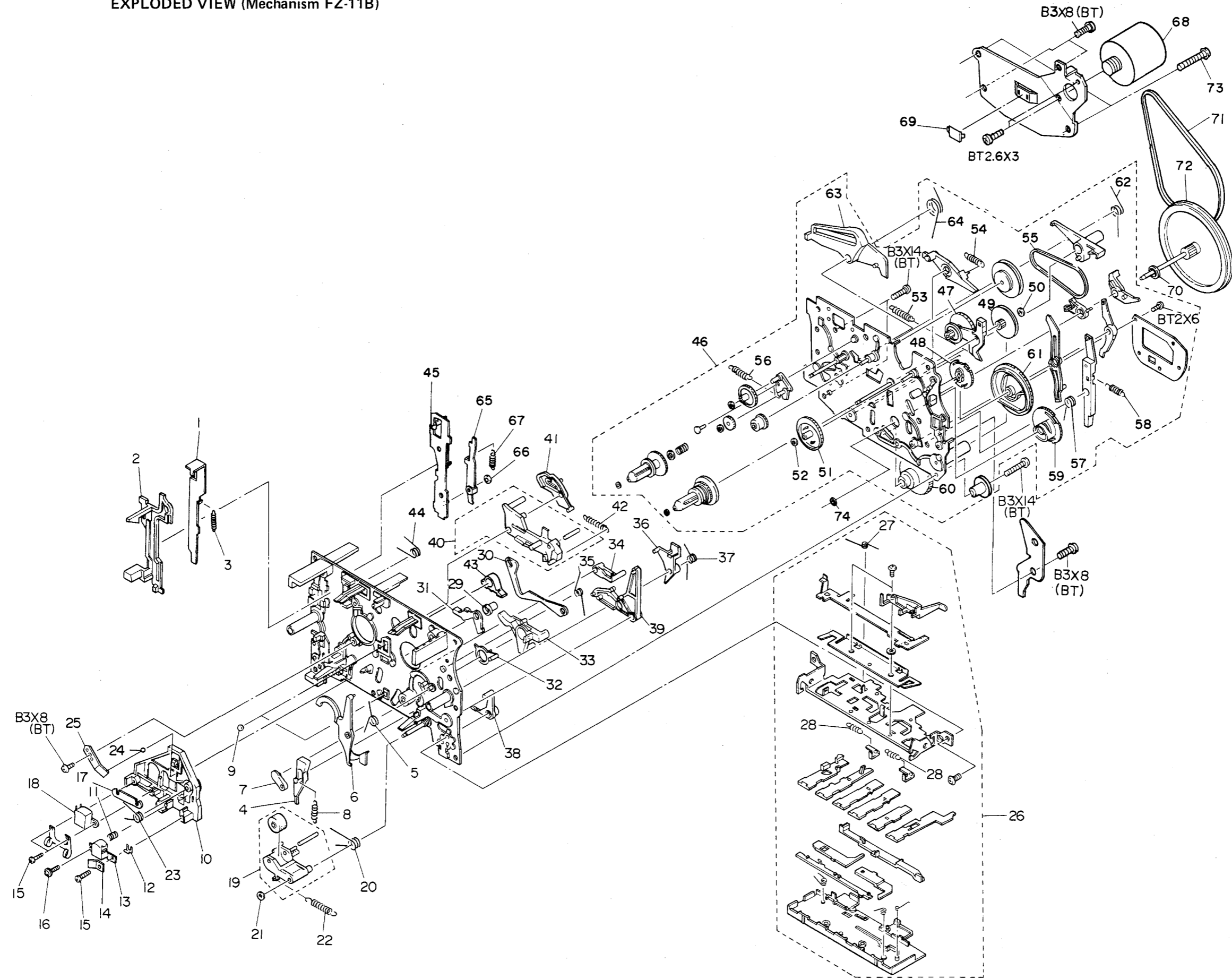

Note: Components marked without numbers in this drawing are not specified as replacement parts.

SYMBOL-NO	P-NO	DESCRIPTION	SYMBOL-NO	P-NO	DESCRIPTION
FOR CASSETTE DECK ASSEMBLY			121	6174501	CORD LID
75	7347152	RECORD LEVER ASSEMBLY	122	7354601	JOINT HOLDER ASSEMBLY
76	6056423	EJECT BUTTON ASSEMBLY	123	6037612	BAFFLE PLATE ASSEMBLY
77	6354472	COUNTER BELT	124	5746991	SPEAKER CORD
78	6542552	REC SPRING	125	5406842	SPEAKER-12CM
79	5559592	COUNTER	126	5409112	SPEAKER-3CM
80	6776151	LED HOLDER	127	5419071	SPEAKER-2CM
MISCELLANEOUS			128	6774412	SPEAKER HOLDER
81	6293901	SLIDE KNOB (BASS,TREBLE,MID)	129	7781147	BT BIND HEAD SCREW-3MMDX30MM
82	6293881	PUSH BUTTON(LOUDNESS,DOLBY)	130	7781132	BT SCREW 3MMDx10MM
83	6293891	PUSH BUTTON (AFC/MODE)	131	6037552	SPEAKER BOX ASSEMBLY(L)
84	6284331	KNOB (TAPE,FUNCTION)	CAPACITORS		
85	6284332	KNOB (BAND)	CT151	5058191	TRIMMER 10PF
86	6284333	KNOB (VOLUME,BALANCE)	CT153-154	5058191	TRIMMER 10PF
87	8698410	BT BIND SCREW-3MMDX10MM	CT156	5058414	TRIMER 20P
88	6037682	FRONT CASE ASSEMBLY	C104	0246444	CERAMIC DISCAL 15PF+-5X
89	7544967	JOINT SHAFT	C108	0248336	CERAMIC DISCAL 18PF+-5X(N=470)
90	7347223	EJECT HOLDER ASSEMBLY	5052781		VARIABLE CAPACITOR
91	6768341	DAMPER	RESISTORS		
92	6094106	CASSETTE LID ASSEMBLY	RC601-602	0186451	CR PACK
93	6057031	FUNCTION BUTTON ASSEMBLY	RT301	5007477	SEMI VARIABLE 10KOHM
94	8699408	BT BIND HEAD SCREW-3MMDX8MM (BLACK)	RT401LR	5007432	SEMI VARIABLE 1.0KOHM
95	6037602	REAR CASE ASSEMBLY (E)	RT402LR	5007701	SEMI VARIABLE 100KOHM
95	6037603	REAR CASE ASSEMBLY (EBS)	RV401LR	5027162	VARIABLE RESISTOR 100KOHM(C)
95	6037604	REAR CASE ASSEMBLY (EZ)	RV402LR	5027161	VARIABLE RESISTOR 100KOHM(B)
95	6037609	REAR CASE ASSEMBLY (E(AU))	RV403LR	5027161	VARIABLE RESISTOR 100KOHM(B)
96	6284091	TUNING KNOB ASSEMBLY	RV404	5000894	VARIABLE RESISTOR 50KOHM(B)
97	6172431	BATTERY LID ASSEMBLY	RV405LR	5000913	VARIABLE RESISTOR 10KOHM(B)
98	6776131	DIAL CORD STRINGING HOLDER ASSEMBLY	R502	0170473	FUSE RESISTOR 4.7OHM+-5X
99	6324112	BATTERY SPRING	SEMI-CONDUCTORS		
100	7450344	BATTERY TERMINAL	DB601	5331452	DIODE SRN02-100NLF
101	7450343	BATTERY TERMINAL	DB602	5331451	DIODE SRP02-100NLF
102	6303973	SPRING	D101	5339021	DIODE 1SS133
103	6303972	SPRING	D102	5330661	DIODE SILICON 1S2790
104	7776471	SPEAKER TERMINAL	D103	5339021	DIODE 1SS133
105	6776161	P.W.B HOLDER	D301	5339021	DIODE 1SS133
106	6776141	HEADPHONE SOCKET HOLDER	D401	5330571	DIODE 1S2473VE
107	7354572	RECORD ARM	D501	5339021	DIODE 1SS133
108	6300593	LOCK SPRING	D601	5330001	RECTIFIER SILICON V03C
109	6346355	PULLEY	IC101	5351902	IC AN7213A
110	6316231	SPRING M	IC201	5368171	IC AN7224
111	6398871	POINTER	IC301	5350684	IC HA1330
112	6334921	HANDLE ASSEMBLY	IC401LR	5369901	IC HA12037
113	6531142	SPRING	IC402	5369891	IC HA12046
114	5752711	TELESCOPIC ANTENNA	IC501	5352141	IC HA1392
115	5687142	CAP TERMINAL	IC701	5352572	IC BA6137
116	8699410	BT BIND HEAD SCREW-3MMDX10MM (BLACK)	LED	5381241	LED ASSEMBLY
117	7781132	BT SCREW 3MMDx10MM	LED301	5380271	LED GL-9PR2
118	7781136	BT SCREW 3MMD x 20MM	LED401	5380281	LED GL-9PG2
119	8678414	DT BIND SCREW-3MMDX14MM	Q171	5323061	TRANSISTOR 2SC380TM-O (EZ)
120	6037542	SPEAKER BOX ASSEMBLY(R)			

SYMBOL-NO	P-NO	DESCRIPTION	SYMBOL-NO	P-NO	DESCRIPTION
SEMI-CONDUCTORS			MISCELLANEOUS		
Q201	5323061	TRANSISTOR 2SC380TM-0		5421921	BUILT IN MICROPHONE
Q401LR	5320069	TRANSISTOR 2SC458CD		5686201	TERMINAL PLATE
Q402	5321293	TRANSISTOR 2SC1740LN-R	BP101	5161551	FILTER
Q403	5320069	TRANSISTOR 2SC458CD	CF201	5160303	CERAMIC FILTER 10.7MHZ
Q404LR	5321293	TRANSISTOR 2SC1740LN-R	CF203	5160065	CERAMIC FILTER 468KHZ
Q405LR	5320069	TRANSISTOR 2SC458CD	CF204	5160381	CERAMIC FILTER 10.7MHZ
Q501	5320643	TRANSISTOR 2SC1162WT-C	△ F602	5721064	FUSE 2.5A
Z0401	5330715	ZENER DIODE HZ28	J 1	5673381	JACK-3.5MMD
Z0501	5330325	ZENER DIODE HZ9A2	J 2LR	5676322	2P PIN JACK
TRANSFORMERS			J 3	5653181	DIN SOCKET
△ PT	5213143	POWER TRANSFORMER [E/EZ]	J 5	5674353	HEADPHONE JACK
△ PT	5213144	POWER TRANSFORMER [E(BS)/E(AU)]	J 6LR	5673381	JACK-3.5MMD
T101	5140071	FM IF TRANSFORMER	△ J 8	5652342	AC-DC SOCKET [E/E(BS)/EZ]
T151	5152372	AM IF TRANSFORMER	△ J8	5652341	AC-DC SOCKET [E/(AU)]
COILS			OSC401	5260981	OSCILLATOR BLOCK
L101	5126482	FM RF COIL	RL501	5641491	RELAY
L102	5126278	FM OSCILLATOR COIL	S 1	5613454	SLIDE ROTARY SWITCH (BAND)
L151	5123493	SW ANTENNA [E,E(BS)]	S 2	5634418	PUSH SWITCH (FM MODE)
L151	5123776	SW ANTENNA COIL [EZ/E(AU)]	S 3	5622301	SLIDE SWITCH (REC/P.B.)
L152-153	5113711	FERRITE ANTENNA	S 4	5613452	SLIDE ROTARY SWITCH (TAPE)
L154	5123678	SW OSCILLATOR COIL	S 5	5613451	SLIDE ROTARY SWITCH (FUNCTION)
L155	5120518	MW OSCILLATOR COIL	S 6	5633792	PUSH SWITCH (DOLBY NR)
L156	5120663	MW OSCILLATOR COIL	S 7	5633792	PUSH SWITCH (LOUDNESS)
L170	5123271	FM TRAP COIL 0.5MH	S 8	5633891	PUSH SWITCH (MOTOR)
L201	5152324	CHOKE COIL 10μH ± 10%	S 9	5633691	PUSH SWITCH (CUE/REV.)
L301LR	5150571	CHOKE COIL 33MH	S 10	5624411	SLIDE SWITCH (RIF)
L401LR	5120566	CHOKE COIL	FOR ACCESSORIES		
L402LR	5162283	LOW PASS FILTER	△	5747324	POWER CORD [E, EZ]
L403LR	5120274	CHOKE COIL	△	5746344	POWER CORD [E(BS)]
L501LR	5150761	CHOKE COIL	△	5747172	POWER CORD [E(AU)]

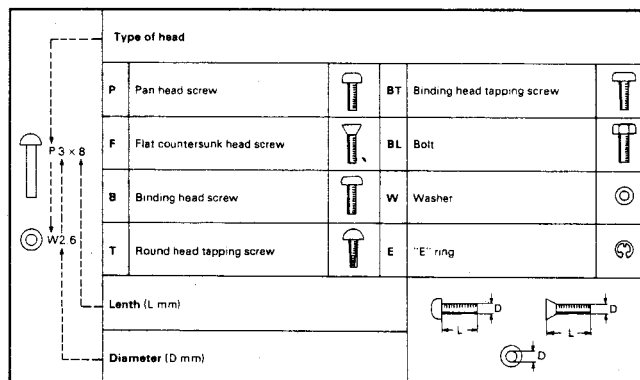

When ordering hardware excluding stated on these lists, be sure to make your orders with type and size.

EXPLODED VIEW (Speaker box)

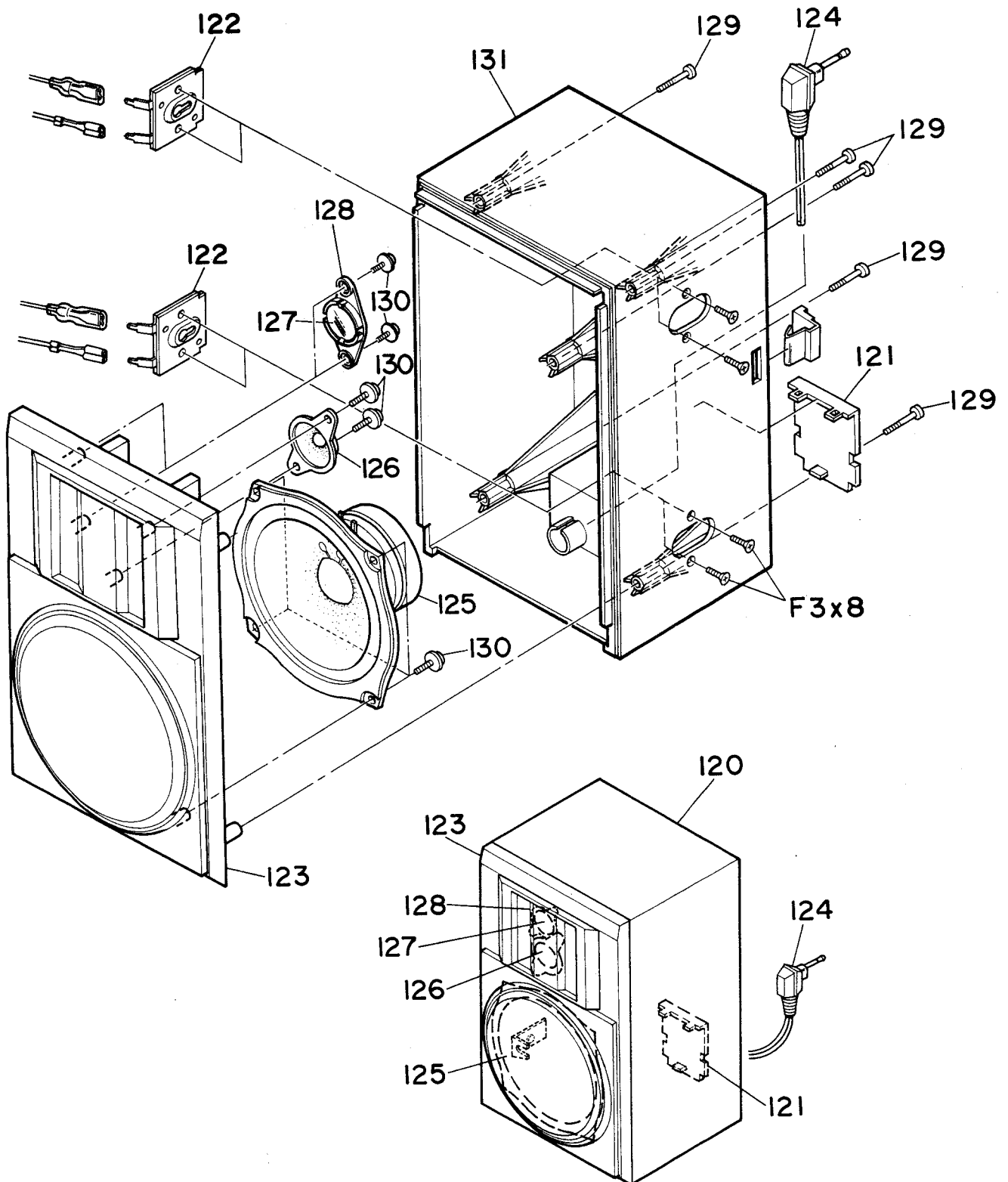

Note: Components marked without numbers in this drawing are not specified as replacement parts.